

Fresh air from

ÖSTBERG
THE FAN COMPANY

RFTX, RKX

Explosion-proof radial and in-line duct fans
with ATEX-certification

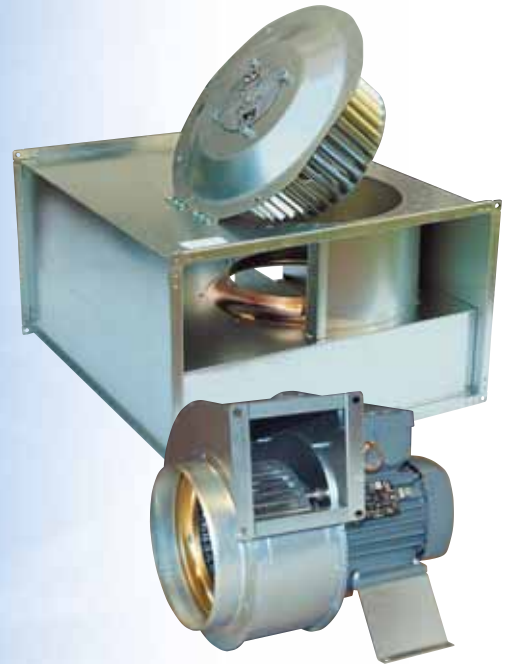

Content

ATEX-CERTIFIED FANS	3
RFTX 140 A	4
RFTX 140 C	4
RFTX 160 A	5
RFTX 160 C	5
RFTX 200 A	6
RFTX 200 B	6
RFTX 200 C	7
RKX 500x250 D3	8
RKX 500x300 B3	8
RKX 600x300 F3	9
RKX 600x350 E3	9
RKX 700x400 B3	10
ACCESSORIES	11
GENERAL FAN FACTS	12-14

WITH A FOCUS ON SAFETY



Our ATEX-certified fans



The European quality and safety standard for explosion-proof fans is called ATEX. AB C.A. Östberg was one of the first fan producers in Europe to achieve ATEX-certification, this certification means that our production of explosion-proof fans are tightly controlled by our independent certification authority.

The ATEX-certified fans are the result of a development at AB C.A. Östberg. Great importance has by us been put into the manufacture of high quality products that are easy to use and install. The explosion-proof fans are the safe choice for numerous applications in hazardous locations.

HIGH QUALITY

All ATEX-certified fans have high quality 3-phase motors and forward curved impellers. They have a rigid housing made of pre-galvanized steel.

RADIAL FAN RFTX

The RFTX range is manufactured with safety features such as a non-sparking inlet cone made from brass and a motor separated from the air-flow. The fan is connected via an integrated terminal box.

The RFTX is available in 3 sizes for air volumes up to 0,5 m³/s.

DUCT FAN RKX

RKX is a rectangular in-line duct fan which is a refinement of our RK fan range. The inlet cone is manufactured in non-sparking copper and the motor is an ATEX-approved external rotor motor.

RKX has the added benefit of a swing-out motor and impeller assembly for safe, easy maintenance and cleaning.

The RKX is available in 5 sizes, for air volumes up to 1,3 m³/s.

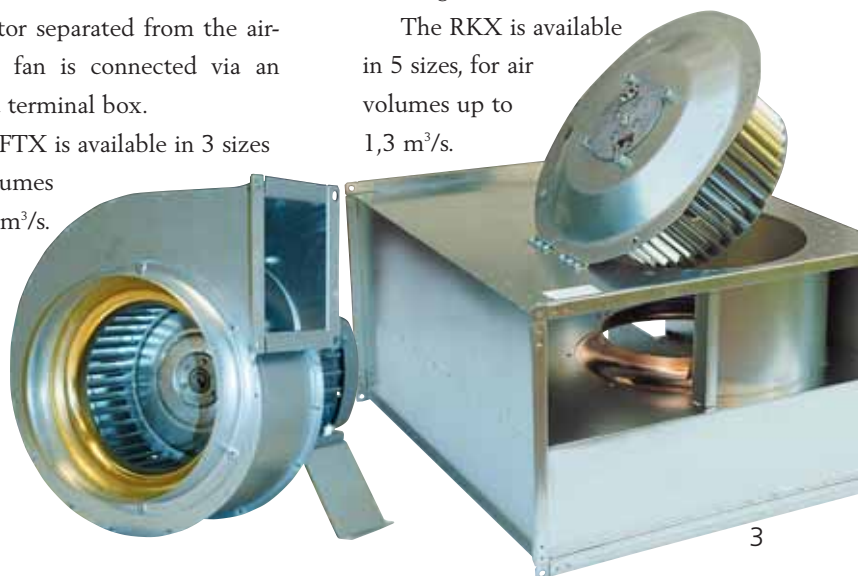

RFTX 140 A

RFTX 140 C

Explosion-proof radial fan

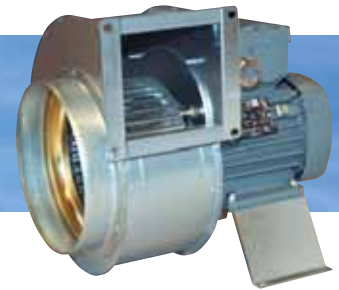

RFTX 140 A

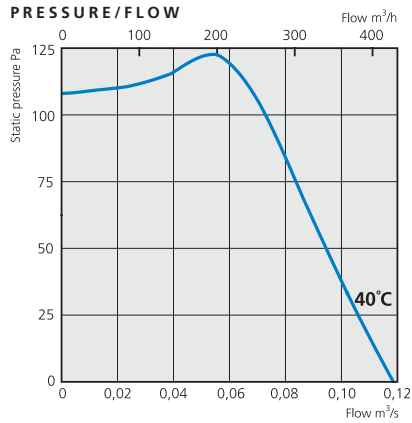

DIMENSIONS (mm)

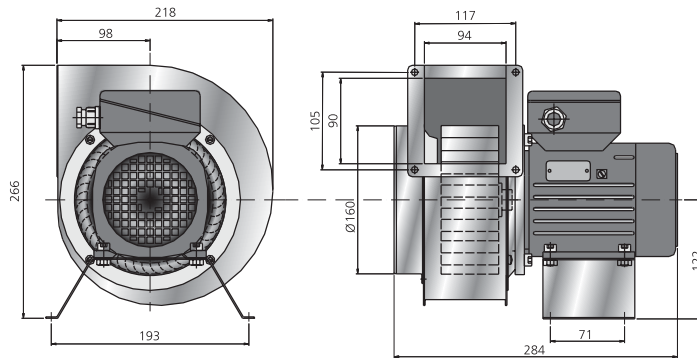

TECHNICAL DATA

Voltage V/Hz	Current A	Input W	Speed rpm	Weight kg	Wiring diagram	Max.temp °C	Temperature class	Insulation class	Motor protection
400/50	0,52	110	1300	7,3	4040116	+40	T3	F	IP 55

SOUND DATA

RFTX 140 A, 70 l/s 105 Pa	L _{pA}	L _{WA} tot dB (A)	63	125	250	500	1K	2K	4K	8K
Inlet	53	57	40	52	52	52	49	46	38	26
Outlet	54	58	44	53	53	52	51	43	37	26
Environment	52	56	30	25	39	47	54	52	40	39

General fan facts on page 12-14.

ACCESSORIES

Circular outlet pipe, motor protection

RFTX 140 C

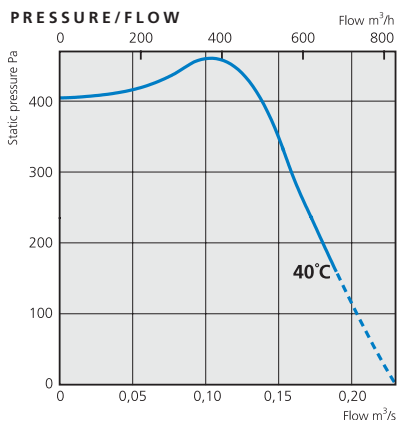

DIMENSIONS (mm)

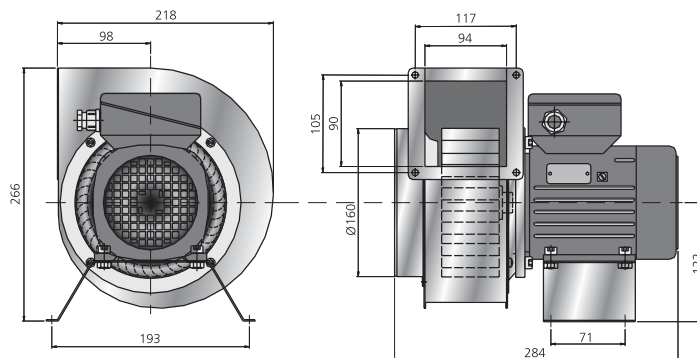

TECHNICAL DATA

Voltage V/Hz	Current A	Input W	Speed rpm	Weight kg	Wiring diagram	Max.temp °C	Temperature class	Insulation class	Motor protection
400/50	0,53	300	2810	7,3	4040116	+40	T3	F	IP 55

SOUND DATA

RFTX 140 C, 150 l/s 335 Pa	L _{pA}	L _{WA} tot dB (A)	63	125	250	500	1K	2K	4K	8K
Inlet	72	76	58	65	72	72	67	68	62	56
Outlet	77	81	64	75	76	74	71	72	64	59
Environment	60	64	34	35	51	55	60	60	57	51

General fan facts on page 12-14.

ACCESSORIES

Circular outlet pipe, motor protection

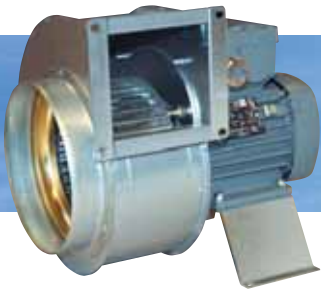

RFTX 160 A

RFTX 160 C

Explosion-proof radial fan

RFTX 160 A

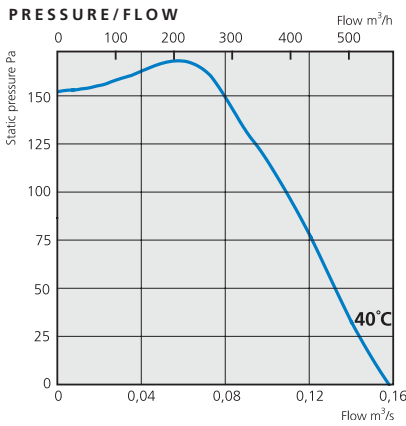

DIMENSIONS (mm)

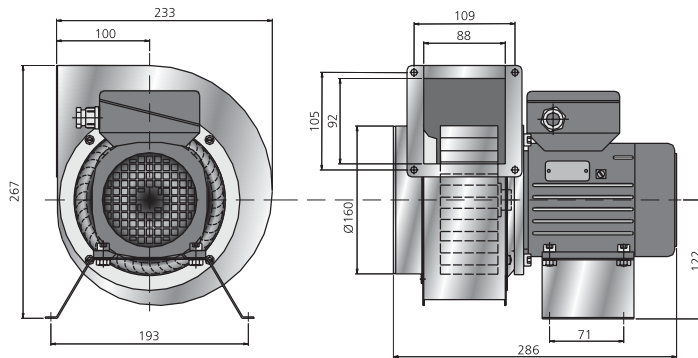

TECHNICAL DATA

Voltage V/Hz	Current A	Input W	Speed rpm	Weight kg	Wiring diagram	Max. temp °C	Temperature class	Insulation class	Motor class
400/50	0,53	143	1300	7,9	4040116	+40	T3	F	IP 5

SOUND DATA

RFTX 160 A, 105 l/s 110 Pa	L_{pA}	L_{WA}	tot dB (A)	63	125	250	500	1K	2K	4K	8K
Inlet	59	63	63	50	56	58	57	56	53	47	37
Outlet	60	64	64	50	56	58	57	59	53	48	40
Environment	53	57	57	29	28	39	48	52	54	43	40

ACCESSORIES

Circular outlet pipe, motor protection

General fan facts on page 12-14.

RFTX 160 C

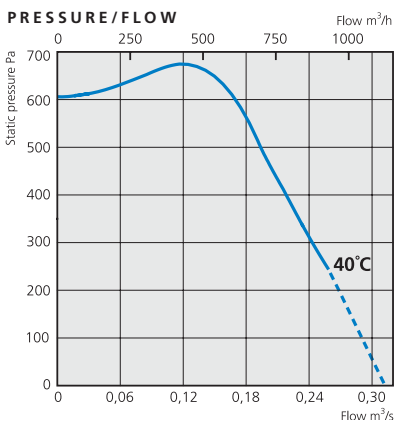

DIMENSIONS (mm)

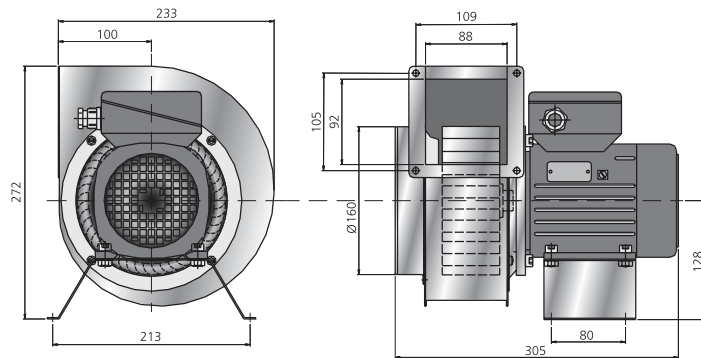

TECHNICAL DATA

Voltage V/Hz	Current A	Input W	Speed rpm	Weight kg	Wiring diagram	Max. temp °C	Temperature class	Insulation class	Motor class
400/50	0,97	590	2740	9,5	4040116	+40	T3	F	IP 55

SOUND DATA

RFTX 160 C, 190 l/s 510 Pa	L_{pA}	L_{WA}	tot dB (A)	63	125	250	500	1K	2K	4K	8K
Inlet	74	78	78	59	66	74	73	70	69	65	57
Outlet	80	84	84	71	78	80	77	73	72	67	61
Environment	64	68	68	43	35	54	58	62	64	62	54

ACCESSORIES

Circular outlet pipe, motor protection

General fan facts on page 12-14.

RFTX 200 A

RFTX 200 B

Explosion-proof radial fan

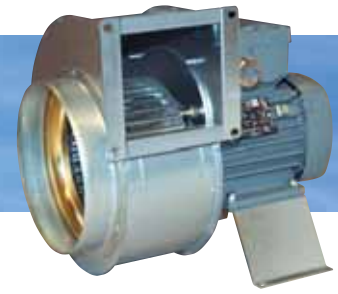

RFTX 200 A

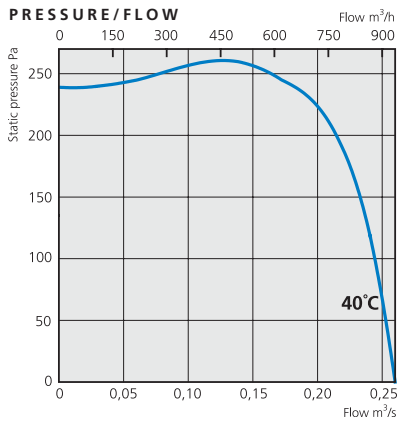

DIMENSIONS (mm)

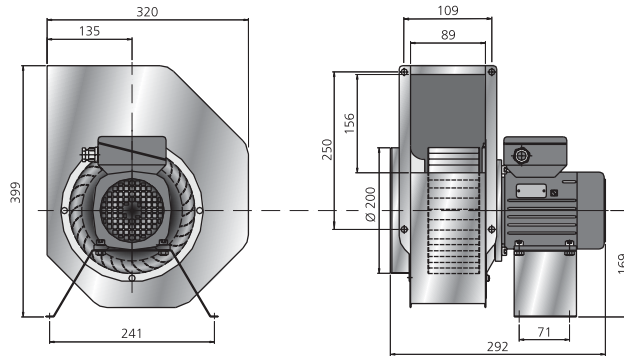

TECHNICAL DATA

Voltage V/Hz	Current A	Input W	Speed rpm	Weight kg	Wiring diagram	Max.temp °C	Temperature class	Insulation class	Motor class
400/50	0,60	270	1300	9,1	4040116	+40	T3	F	IP 55

SOUND DATA

RFTX 200 A, 150 l/s 255 Pa	L_{pA}	L_{WA}	tot dB (A)	63	125	250	500	1K	2K	4K	8K
Inlet	64	68	59	60	57	60	63	60	57	49	
Outlet	66	70	61	63	61	61	64	60	60	52	
Environment	54	58	29	30	43	51	54	54	48	44	

General fan facts on page 12-14.

ACCESSORIES

Circular outlet pipe, motor protection

RFTX 200 B

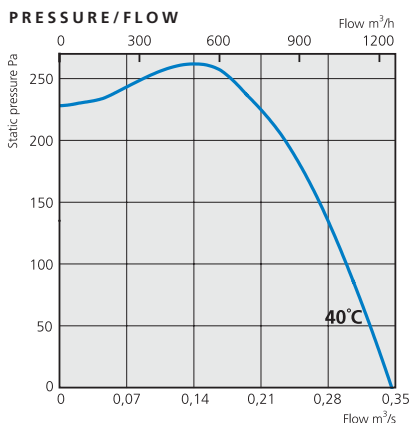

DIMENSIONS (mm)

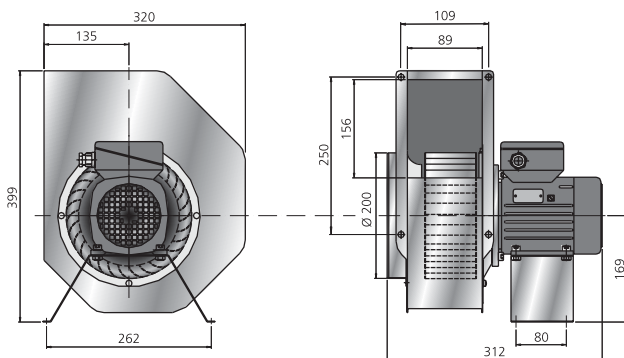

TECHNICAL DATA

Voltage V/Hz	Current A	Input W	Speed rpm	Weight kg	Wiring diagram	Max.temp °C	Temperature class	Insulation class	Motor class
400/50	0,79	388	1380	10,7	4040116	+40	T3	F	IP 55

SOUND DATA

RFTX 200 B, 230 l/s 205 Pa	L_{pA}	L_{WA}	tot dB (A)	63	125	250	500	1K	2K	4K	8K
Inlet	70	74	62	69	68	63	67	64	61	54	
Outlet	72	76	65	71	70	65	68	64	64	57	
Environment	56	60	33	32	46	53	56	54	50	47	

General fan facts on page 12-14.

ACCESSORIES

Circular outlet pipe, motor protection

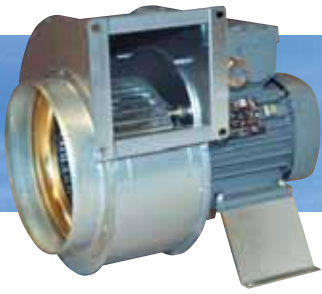

RFTX 200 C

Explosion-proof radial fan

RFTX 200 C

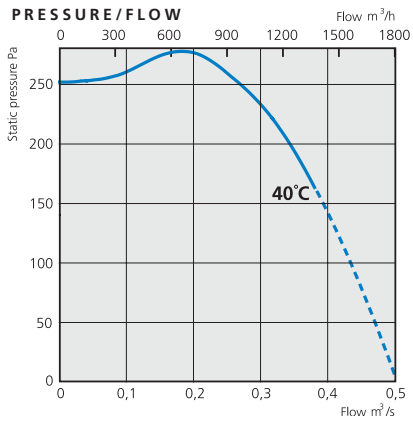

DIMENSIONS (mm)

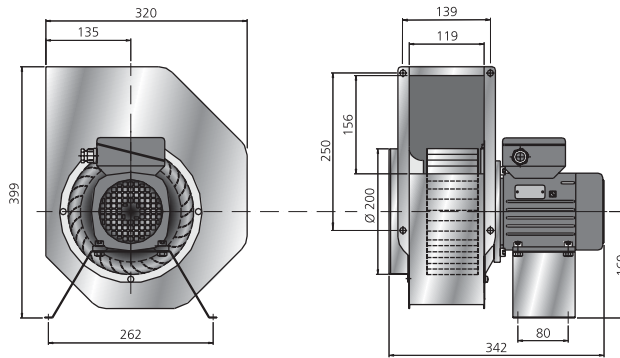

TECHNICAL DATA

Voltage	Current	Input	Speed	Weight	Wiring	Max.temp	Temperature	Insulation	Motor
V/Hz	A	W	rpm	kg	diagram	°C	class	class	class
400/50	0,79	385	1380	11,0	4040116	+40	T3	F	IP 55

SOUND DATA

RFTX 200 C, 380 l/s 165 Pa	L _{pA}	L _{wA}	tot dB (A)	63	125	250	500	1K	2K	4K	8K
Inlet	78	82	67	77	80	73	71	67	64	57	
Outlet	82	86	68	79	84	75	73	69	66	59	
Environment	60	64	38	38	51	56	60	58	55	50	

General fan facts on page 12-14.

ACCESSORIES

Circular outlet pipe, motor protection

RKX 500 x 250 D3

RKX 500 x 300 B3

Explosion-proof in-line duct fan



RKX 500 x 250 D3

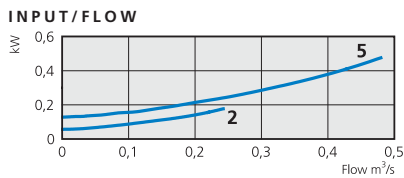
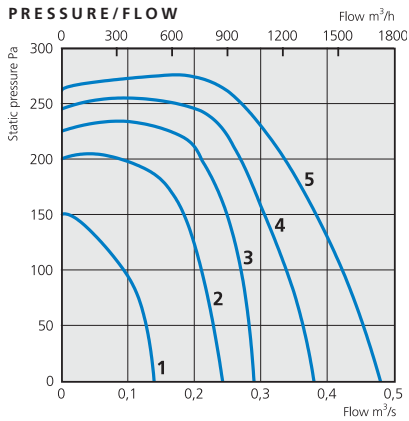

ACCESSORIES

Terminal box, external motor protection

TECHNICAL DATA

Voltage V/Hz	400/50
Current A	0,92
Input kW	0,5
Speed rpm	1285
Weight kg	18
Wiring diagram	4040115
Max.temp °C	+40
Temperature class	T3
Insulation class	F
Motor class	IP 44

DIMENSIONS (mm)

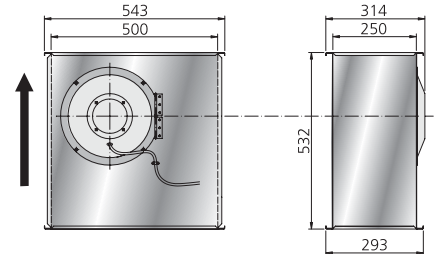

SOUND DATA

259 l/s 273 PaTot	L _{pA}	L _{wA} tot dB (A)	63	125	250	500	1K	2K	4K	8K
Environment 400 V	56	63	38	43	56	57	58	54	49	43
5. Inlet 400 V		73	63	65	66	62	63	65	65	60
4. Inlet 240 V		72	62	63	66	62	63	65	64	59
3. Inlet 185 V		69	59	60	62	62	60	61	60	54
2. Inlet 145 V		65	54	55	58	59	55	56	55	47
1. Inlet 95 V		58	45	45	51	55	44	44	38	27
Outlet 400 V		79	63	63	67	70	73	73	72	67

General fan facts on page 12-14.

RKX 500 x 300 B3

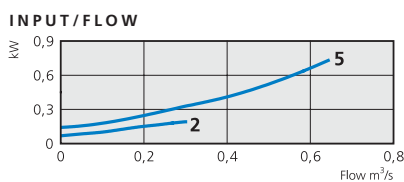
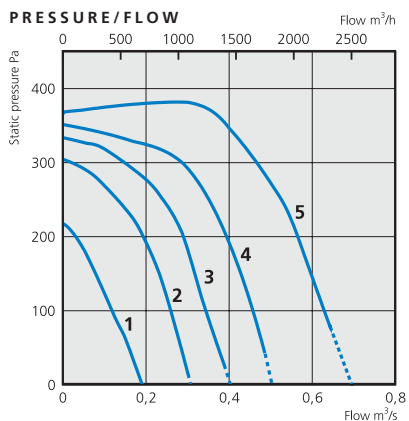

ACCESSORIES

Terminal box, external motor protection

TECHNICAL DATA

Voltage V/Hz	400/50
Current A	1,54
Input kW	0,8
Speed rpm	1239
Weight kg	22
Wiring diagram	4040115
Max.temp °C	+40
Temperature class	T3
Insulation class	F
Motor class	IP 44

DIMENSIONS (mm)

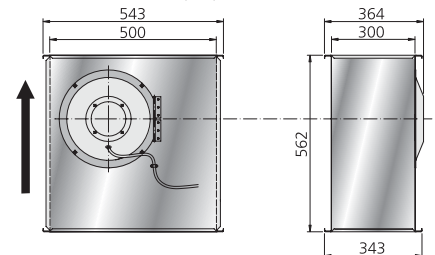

SOUND DATA

321 l/s 372 PaTot	L _{pA}	L _{wA} tot dB (A)	63	125	250	500	1K	2K	4K	8K
Environment 400 V	55	62	37	48	56	53	59	52	51	45
5. Inlet 400 V		73	63	68	66	59	64	65	64	58
4. Inlet 240 V		72	61	64	64	61	62	65	63	57
3. Inlet 185 V		68	58	61	60	58	59	60	59	51
2. Inlet 145 V		63	53	55	56	54	53	55	52	42
1. Inlet 95 V		54	44	48	50	46	45	43	37	26
Outlet 400 V		79	63	66	68	70	75	72	72	66

General fan facts on page 12-14.



RKX 600 x 300 F3 RKX 600 x 350 E3

Explosion-proof in-line duct fan

RKX 600 x 300 F3

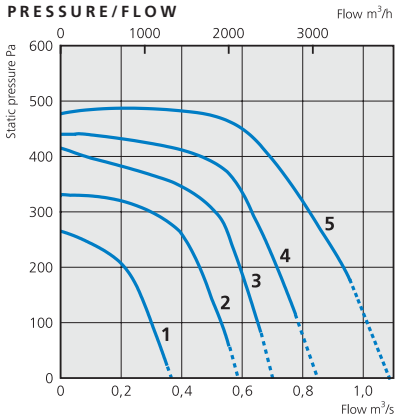

TECHNICAL DATA

Voltage V/Hz	230/50 400/50
Current A	5,28/3,05
Input kW	1,5
Speed rpm	1343
Weight kg	32
Wiring diagram	4040003/4040004
Max.temp °C	+40
Temperature class	T3
Insulation class	F
Motor class	IP 44

DIMENSIONS (mm)

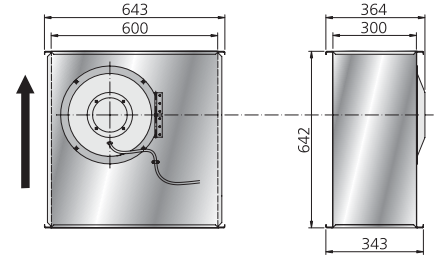

INPUT/FLOW

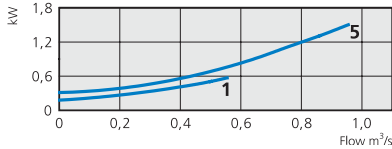

SOUND DATA

512 l/s 452 PaTot	L _{pA}	L _{wA}	tot dB (A)	63	125	250	500	1K	2K	4K	8K
Environment 400 V	60	67	50	54	59	58	63	60	57	52	
5. Inlet 400 V		78	66	71	70	65	72	70	69	64	
4. Inlet 240 V		78	65	69	70	64	72	70	69	65	
3. Inlet 185 V		76	64	67	68	63	70	68	68	63	
2. Inlet 145 V		73	62	64	65	61	67	65	65	59	
1. Inlet 95 V		65	56	57	58	55	58	57	56	47	
Outlet 400 V	86	67	70	75	75	80	80	79	74		

ACCESSORIES

Terminal box, external motor protection

General fan facts on page 12-14.

RKX 600 x 350 E3

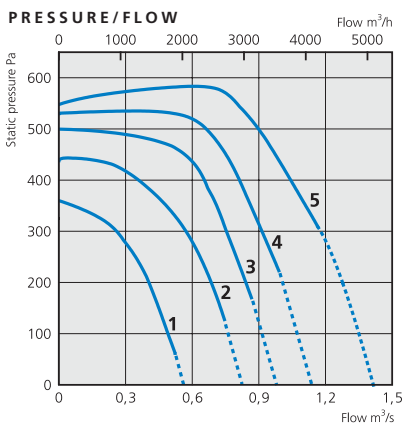

TECHNICAL DATA

Voltage V/Hz	230/50 400/50
Current A	6,93/4,00
Input kW	2,0
Speed rpm	1375
Weight kg	43
Wiring diagram	4040003/4040004
Max.temp °C	+40
Temperature class	T3
Insulation class	F
Motor class	IP 44

DIMENSIONS (mm)

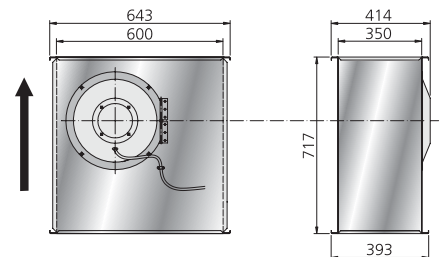

INPUT/FLOW

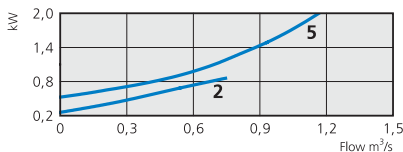

SOUND DATA

665 l/s 598 PaTot	L _{pA}	L _{wA}	tot dB (A)	63	125	250	500	1K	2K	4K	8K
Environment 400 V	61	68	48	56	60	58	64	61	60	56	
5. Inlet 400 V		79	69	71	70	67	72	72	71	67	
4. Inlet 240 V		79	68	69	69	67	72	72	71	67	
3. Inlet 185 V		77	66	68	68	66	70	71	70	66	
2. Inlet 145 V		75	64	65	66	64	67	68	67	62	
1. Inlet 95 V		69	60	60	61	59	61	62	60	53	
Outlet 400 V	87	71	73	75	78	82	81	80	76		

ACCESSORIES

Terminal box, external motor protection

General fan facts on page 12-14.

RKX 700 x 400 B3

Explosion-proof in-line duct fan



RKX 700 x 400 B3

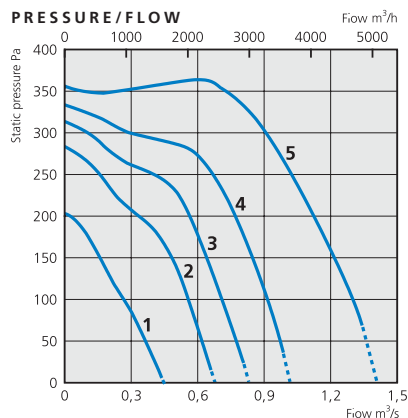

TECHNICAL DATA

Voltage V/Hz	230/50 400/50
Current A	4,30/2,50
Input kW	1,4
Speed rpm	799
Weight kg	50
Wiring diagram	4040003/4040004
Max. temp °C	+40
Temperature class	T3
Insulation class	F
Motor class	IP 44

DIMENSIONS (mm)

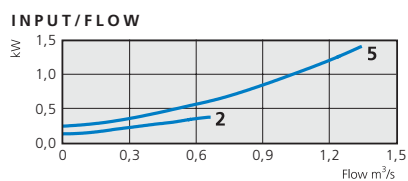
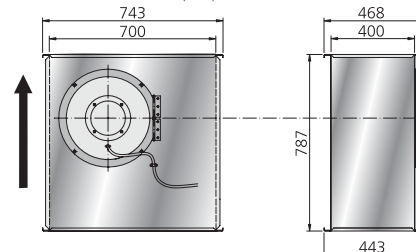

SOUND DATA

717 l/s 342 PaTot	L_{pA}	L_{wA}	tot dB (A)	63	125	250	500	1K	2K	4K	8K
Environment 400 V	55	62	45	52	52	55	56	53	51	46	
5. Inlet 400 V		73	64	65	64	61	67	65	64	58	
4. Inlet 240 V		72	61	62	63	62	66	64	63	56	
3. Inlet 185 V		69	58	59	61	59	62	61	60	51	
2. Inlet 145 V		64	54	55	57	54	58	56	54	44	
1. Inlet 95 V		55	45	47	50	45	49	46	41	30	
Outlet 400 V		81	70	69	72	73	74	74	73	67	

General fan facts on page 12-14.

ACCESSORIES

Terminal box, external motor protection

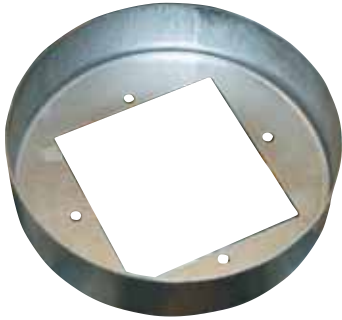

OUTLET PIPE

For connection of RFTX to circular duct there is an outlet pipe as an accessory.



TERMINAL BOX

As an accessory for RKX there is an ATEX-approved terminal box available.



MOTOR PROTECTION

External motor protection special manufactured for ATEX-certified duct fans RKX and RFTX.

The picture shows motor protection for RKX.

GENERAL FAN FACTS

SECURITY AND APPLICATION

- The fans are certified according to ATEX 94/9/EEC and comply with ISO 14694, category BV-2, BV-3 and ISO 1940 quality factor G 6.3.
- Standards: SS-EN 50014:1997, SS-EN 50019, EN 13463-1 and parts of prEN 14986:2006.
- There are two versions of fan motors that have different rate data.
- The fans are adapted to transport gas in explosion environment.
- The fans must not be connected to a flue gas duct.
- The fans are powered by short-circuit 3-phase motor.
- The fans are adapted for continuously operation S1.
- The fans must not be installed outside.
- The fans can only be used in zone 1 and are not zone separating, i.e. transported air and ambient air of the fan must be in the same zone.
- The environmental temperature of the fan and the temperature of the media that is transported can be max +40°C.
- The fans must not be used to transport media (compact or running) that can establish sediments or corrosiveness on the impeller, motor or casing.
- Rst particles are not to occur in the airflow.
- The fan can be installed vertically or horizontally.
- At speed regulation the fans can be run by a transformer with a voltage of 25% up to 100% of the rated voltage. If the transformer is installed in the same zone as the fan, it must have the similar ATEX classification.
- The fans cannot be electronic regulated or regulated with a frequency converter.
- The fans must be connected electrically via a re-setting proof vertical discharge with a contact clearance of at least 3 mm/pole.

INSTALLATION

- Installation and maintenance according to the applicable national rules. For members of CENELEC in European countries should the national standards based on EN 60079-14 and EN 60079-17 be take into consideration.
- For the electrical connection see wiring diagram.
- Check possible transport damages of the fan. A damage fan must not be installed in any circumstances.
- Check the distance between the impeller and inlet cone and the distance between the impeller and the casing. These distances must be a minimum of 4 mm.
- Installation and starting must be made by an authorised electrician according to directions and requirements. Electrical installation must be made according to EN 60079-14 that complies with the safety requirements of high tension current.
- Installation according to appended wiring diagram.
- The fan must be grounded.

- An external motor protection must be installed (is an accessorie). If the motor protection is installed in the same zone as the fan, it must have the similar ATEX classification.
- Before starting, the fans must be connected to duct or equipped with a safety grill to preclude contact of moving parts (EN 294).
- The fans are only intended for firm installation.
- The fans should be installed in a safe way, not risking to fall off, to be expose for or cause vibrations.
- If installation cause vibrations, the fans must be connected to duct via a flange.
- Precautions must be taken to prevent material to be sucked or fall into the fan, when vertically mounted. Minimum IP 20 ≤ Ø12,5 mm at the inlet side and IP 10 ≤ Ø 50 mm at the outlet side.
- The fan must be installed according to the air direction label.
- The fan should be installed in a way that makes service and maintenance easy and safe.

OPERATION

Before starting, make sure that:

- the fan is installed and electrically connected in the correct way with ground and a motor-protection.
- no foreign objects are in the fan and no noise appears when starting the fan.
- the rotation direction are according to the label. If the fan rotates in wrong direction, change place of 2 phases and rotation direction will be right.
- the current does not exceed what is stated on the label.

HOW TO HANDLE

- The fans must be stored in a dry place.
- If the fans have been stored for a long time, the ball-bearings of the fan must be checked before starting so it operates properly.
- Avoid storage longer than one year.
- The fan must be transported in its packing until installation. This prevents transport damages, scratches and the fan from getting dirty.
- Use an adequate cable lift when handling the fans to avoid damages of fans and people.
- The fans must not be lifted in the motor cable, impeller or inlet cone.
- Attention, look out for sharp edges and corners.

MAINTENANCE

- Before service, maintenance or repair begins, the fan must be tension free and the impeller must have stopped.
- Consider the weight of the fan when removing or opening larger fans to avoid jamming and contusions.
- The fan must be cleaned when needed, at least once per year to maintain the capacity and to avoid unbalance, which may cause unnecessary damages on the bearings.

- When cleaning the fan, also check if the fan has any damages in a way that can cause a change of the distance between impeller and inlet cone or the distance of impeller and the casing. If so, the fan needs to be exchange.
- The fan bearings are maintenance-free and have a lifetime of about 30.000-40.000 operation hours or 5 years. Contact the fan supplier to renew the bearings.
- When cleaning the fan, high-pressure cleaning or strong dissolvent must not be used. Cleaning should be done without dislodging or damaging the impeller.
- Make sure that there is no noise from the fan.
- The screws tightening capacity of the service lid: M6=9,8 Nm; M10=45 Nm.
- Components in ATEX-approved products **must not** be repaired or change.

FAULT DETECTION

If the fan has stopped or do not start.

1. Make sure that there is tension to the fan.
2. Cut the tension and verify that the impeller is not blocked.
3. Check the motor protector. If it is disconnected the cause of overheating must be taken care of, not to be repeated.
4. If nothing of this works, contact your fan supplier.
5. At possible complaint, the fan must be cleaned, the motor cable undamaged and a detailed nonconformity report enclosed.

CONDITIONS ACCORDING TO CERTIFICATE SP06ATEX3127X

1. The thermal PTC-circuit of the motor must be connected to a thermo-contact relay, (Certified according to directive 94/9/EC) which cut the motorsupply when motor temperature is to high.
2. Connected fan to duct system must be installed with requirements of rate IP 20 on inlet side and IP 10 on outlet side. The parts that are included in these IP-protections must be constructed in an appropriate way, in strength and material.
3. To avoid explosion hazard, the connection cable of the fan must be rigid connected, mechanically protected and protected from other environmental influence. To protect from explosion the free cable end must be connected according to installation requirement.
4. The stated current on the marking sign must not be exceeded. If the fans are speed regulated by a transformer the current can be exceeded for some of the fans according to the table in the certificate. But only if the rated power is not exceeded.

GENERAL FAN FACTS

Marking terminology ATEX

- 1 Category 2 = zone 1, G = gas.
Danger zone where explosive gas can occur temporary during normal operation.
- 2 Equipment group II (not for mines).
- 3 Symbol for explosion proof material.
- 4 Certified number.
- 5 SP notified body number.
- 6 Certified with European standards (CENELEC standard).
- 7 Explosion proof material.
- 8 Increased security = Sparks do not appear in the equipment.
- 9 Explosion group: IIA (propane gas), IIB (ethylene gas) + H2 (hydrogen gas).
- 10 Temperature class T3. Can be used in gases with an ignition temperature $\geq 200^{\circ}\text{C}$.

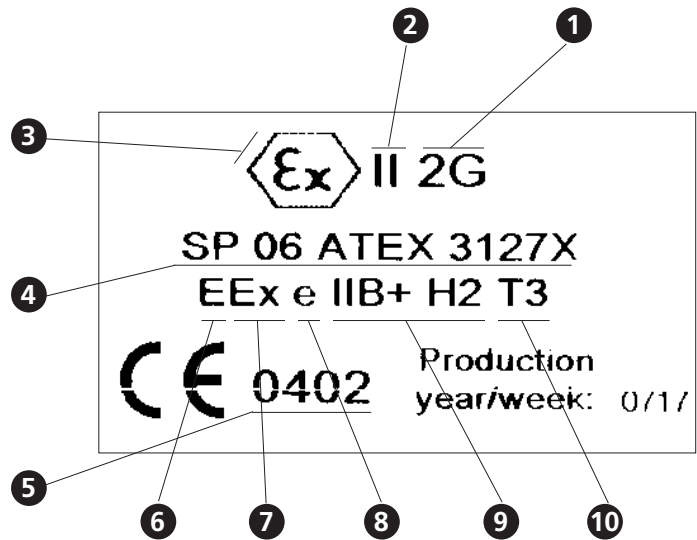

Wiring diagrams

4040003
3-phase, 400V

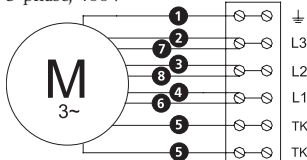

- (M) = Fan Motor
- (M1) = Fan Motor
- (M2) = Fan Motor
- (M3) = Rotor Motor
- 1 = Yellow/Green
- 2 = Black
- 3 = Blue
- 4 = Brown
- 5 = White (TW)
- 6 = Orange
- 7 = Grey
- 8 = Red

4040004
3-phase Y 400 V

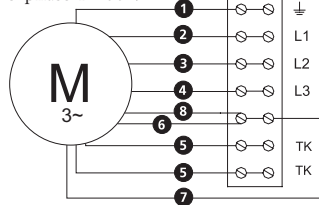

4040115
3-phase Y 400 V

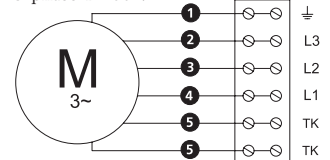

4040116
3-phase Y 400 V

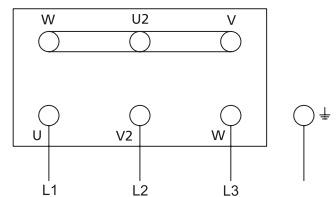

Key to model types

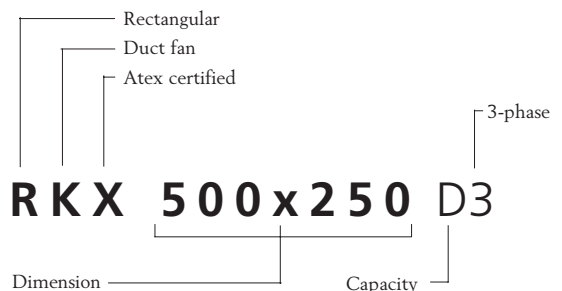
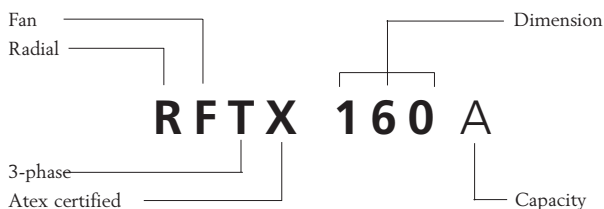

GENERAL FAN FACTS

Pressure/flow-curves explanation

FIG. 1:

The fan curve describes the capacity of the fan, i.e. the flow of the fan at different pressures at a certain input voltage.

The fan diagram has the pressure in Pascal, Pa, on the vertical axis and the flow in cubic metres per second, m³/s, on the horizontal axis.

The point on the fan curve showing the current pressure and flow is called the fans working point. In our example it is marked with P.

If the pressure increases in the ducts, the working point moves along the fan curve and hence a lower flow is obtained. In the example the working point would move from P1 to P2.

FIG. 2:

The system line describes the total behaviour of a ventilation system (ducts, silencers and valves etc.).

Along this system line, S, the working point is moved from P2 to P3 as the rotational speed is changed.

Distinct voltage steps with eg. a transformer produces different fan curves, 135 V and 230 V, indicated in the example.

FIG. 3:

Our fan curves present the total pressure in Pascal. Total pressure = Static + Dynamic pressure.

The static pressure is the pressure of the fan compared to the atmospheric pressure. It is this pressure that shall overcome the pressure losses of the ventilation system.

The dynamic pressure is a calculated pressure that arises at the outlet of the fan, and is mostly due to air velocity. The dynamic pressure thus describes how the fan is working. The dynamic pressure is presented with a curve, starting at origo, that increases with increased flow. A high dynamic pressure can with wrong duct connection produce a high pressure loss. If the pressure loss in the system is known, a fan whose difference between the total and the dynamic pressure corresponds to the pressure loss in the system must be found.

FIG. 1:

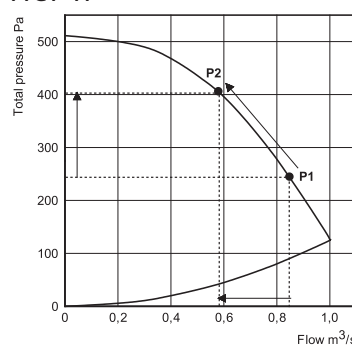

FIG. 2:

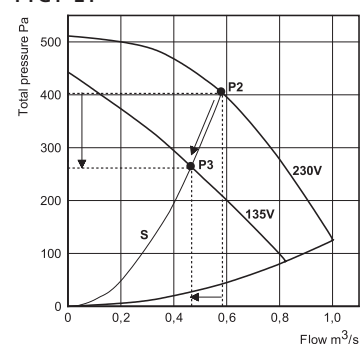
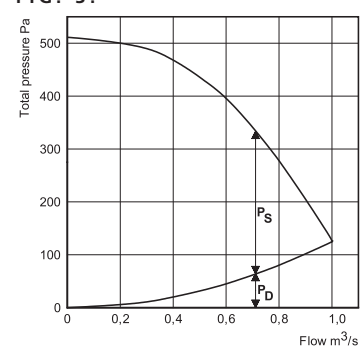

FIG. 3:



Sound data explanation

SOUND DATA IN THIS BROCHURE IS BASED ON FOLLOWING DEFINITIONS:

The points for which the sound data is presented are along the system line defined by the pressure and flow stated in the sound data table for each fan. There are three types of sound in these tables; inlet- and outlet sound are measured in duct, while the surrounding sound is measured outside the fan and duct system. For all these types of sound, the sound power levels are presented in octave bands. For the surrounding sound, also the sound pressure level has been calculated.

THE SOUND POWER LEVEL

The sound power level, Lw(A) is used to calculate the sound from the whole ventilation system. This system can be a composition of grilles, dampers and diffusers for example.

The sound power level is a measured value according to standards, and it does not tell how the sound appears as the sound power is independent of the characteristics of the placement of the fan. In order to resemble the human ear, the A-filter is used indicated with Lw(A) measured in dB(A).

THE SOUND PRESSURE LEVEL

The sound pressure level, Lp or Lp(A), tells how the human ear registers the sound. It is dependent on the sound power level, distance from the source, restrictions of the propagation and the acoustic characteristics of the room.

The sound pressure level is presented for a room with an equivalent absorption area of 20 m² at a distance of 3 m, where the sound is emitted in a semi spherical propagation.

The sound pressure level can be calculated as:

$$L_p = L_w + 10 \log(Q/4\pi r^2 + 4/A)$$

where A is the room's equivalent absorption area and Q is the propagation type:

- Q=1 is spherical propagation
- Q=2 is semi spherical propagation
- Q=4 is quarter spherical propagation.

Thus, for the above specified properties of the placement of the fan, the difference between sound pressure and sound power is:

$$L_p - L_w = 10 \log(2/4\pi 3^2 + 4/20) = -7 \text{ dB}$$

which is the difference that can be seen in the tables of sound data for each fan. For the free field case, i.e. from a roof fan, the sound pressure level is calculated as:

$$L_p = L_w + 10 \log(2/4\pi r^2)$$

Temperature of transported air

In pressure/flow diagrams or in the table of technical data there are facts about highest temperature of transported air.

All motors have insulation class F which means that the thermal contact disconnects the power when the winding temperature is maximum 155°C. At this winding temperature the life time of the ball bearings is not optimal. This

is why the ambient temperature is shown at a lower winding temperature so the life time of ball bearings becomes optimal.

The winding temperature varies in the diagrams and depending on differences in power/ current consumption. The temperatures in our diagrams are given at the highest winding temperature.

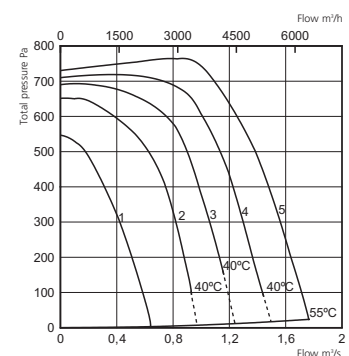



ÖSTBERG - THE FAN COMPANY

Östberg – The Fan Company is one of the leading producers of centrifugal in-line duct fans in the world.

30 years ago the founder and owner was one of them who invented the first centrifugal in-line duct fan in the history.

We have continued to develop new products and today we offer a wide product range of centrifugal in-line duct fans.

Our goal has always been to offer quality products at competitive prices.

Fresh air from

ÖSTBERG
THE FAN COMPANY 

AB C.A. Östberg
Industrigatan 2, SE-774 35 Avesta, Sweden
Tel: +46 226 860 00
Fax: +46 226 860 05
E-mail: info@ca-ostberg.se
www.ostberg.com