

ROOF FANS



BACF

AC AXIAL ROOF FANS Horizontal Outlet

It is designed as maintenance-free for a long time. With highly efficient and esthetic structure, it can be mounted at a desired angle. With the ability of both suction and blowing, these fans provide suction and air supply.

Technical Drawings

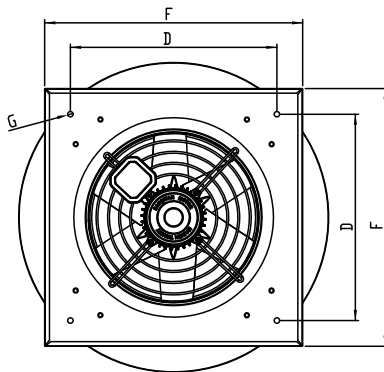
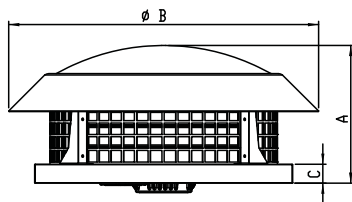

Between BACF 300 and BACF 500

MATERIAL

: The housing is made of electrostatic powder coated sheet iron; axial impeller is made of glass fiber mixed plastic.

INSULATION CLASS

: Class F

DIRECTIVE

: EN 60335-1, EN 60335-2-80

SPEED CONTROL

: Speed can be adjusted using an optional controller.

APPLICATION AREAS

: **Residential** ; bathrooms, toilets, utility rooms, indoor swimming pools, gyms, and storerooms.
Commercial ; cafes, bars, restaurants, shops, schools, offices, factories, buildings, warehouses, night clubs, pubs, hotels, shopping centers, and leisure centers.
Industrial ; Equipment cooling, workshops, and spot ventilation.

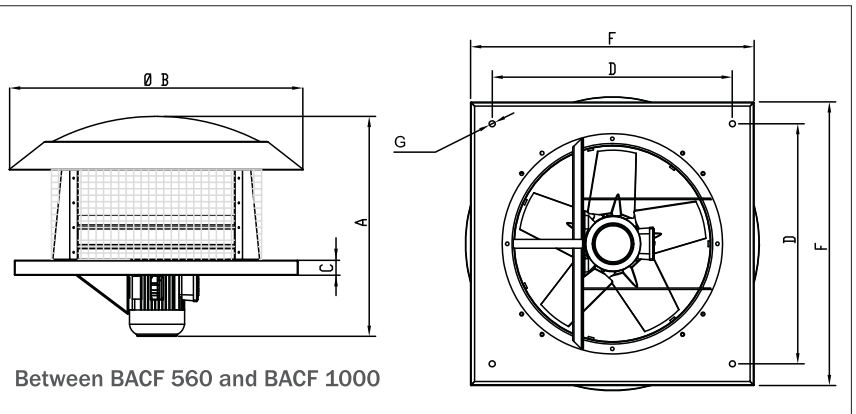

Between BACF 560 and BACF 1000

TYPE	A	B	C	D	F	G
BACF 300	340	685	40	450	560	12
BACF 350	340	685	40	450	560	12
BACF 400	470	824	40	530	630	12
BACF 450	480	824	40	590	710	12
BACF 500	480	824	40	680	740	12
BACF 560	710	1150	40	750	800	15
BACF 630	710	1150	40	750	850	15
BACF 710	800	1150	40	750	850	15
BACF 800	900	1450	40	900	1000	15
BACF 900	900	1450	40	900	1000	15
BACF 1000	950	1450	40	1000	1100	15

Dimensions are in (mm)

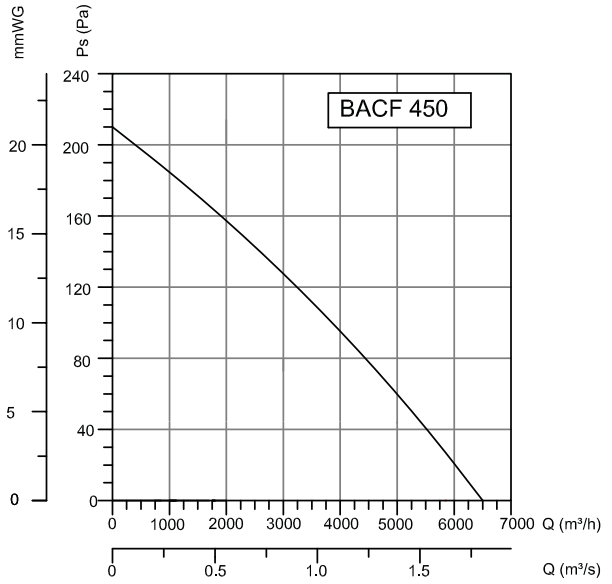
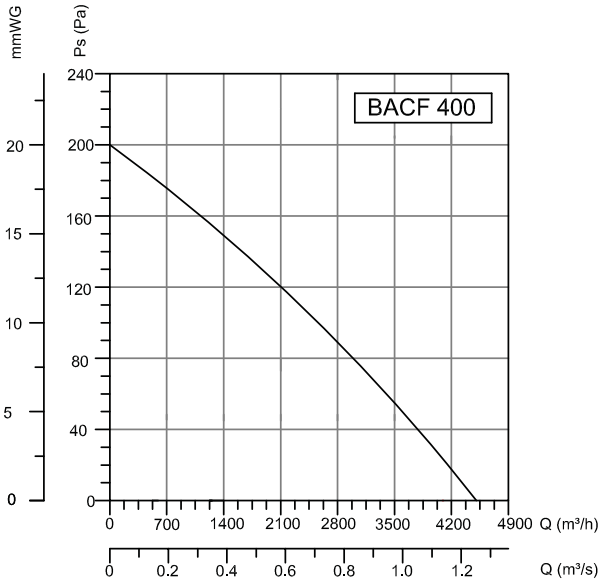
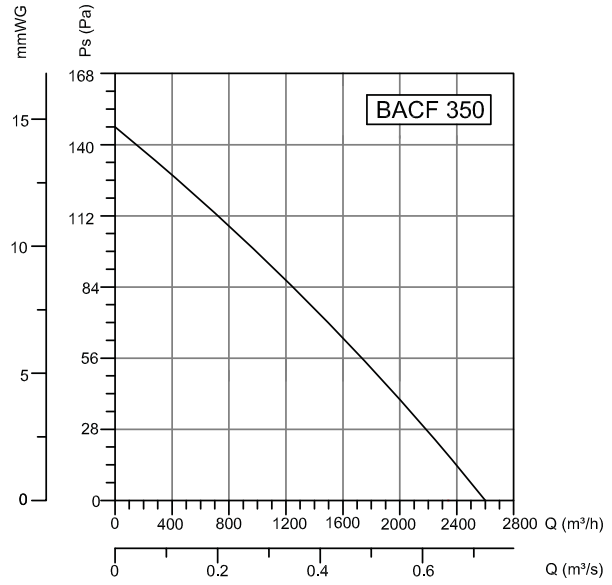
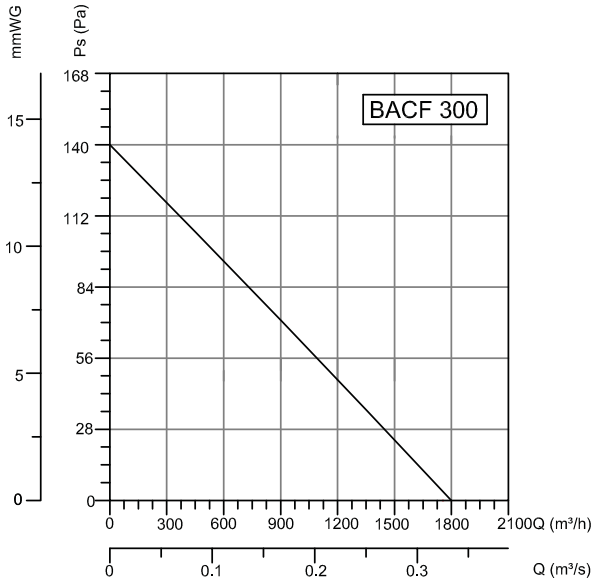

TYPE	VOLTAGE	FREQUENCY	POWER	CAPACITOR	SPEED	AIR FLOW	SOUND PRESSURE LEVEL	WEIGHT
	V	Hz	W	(μ F)	d/d	m ³ /h	dB(A)	kg
BACF 300M / BACF 300T	230/380	50	200	8/-	1430	1800	48	16
BACF 350M / BACF 350T	230/380	50	250	8/-	1360	2600	49	18
BACF 400M / BACF 400T	230/380	50	290	8/-	1400	4500	51	20
BACF 450M / BACF 450T	230/380	50	325	8/-	1375	6500	54	25
BACF 500M / BACF 500T	230/380	50	430	8/-	1350	8500	57	30
BACF 560M / BACF 560T	230/380	50	0,75	20/-	1450	10400	62	37
BACF 630M / BACF 630T	230/380	50	1,1	30/-	1450	14000	63	45
BACF 710M / BACF 710T	230/380	50	1,5	40/-	1450	18000	68	53
BACF 800M / BACF 800T	230/380	50	2,2	50/-	1450	26000	72	75
BACF 900T	380	50	3	-	1450	32000	77	80
BACF 1000T	380	50	5,5	-	1400	42000	91-100	105

DUCT FANS

ROOF FANS

AXIAL FANS

RADIAL FANS

PLASTIC FANS

VENTILATORS

SMOKE EXHAUST SYSTEMS

ACCESSORIES

ROOF FANS

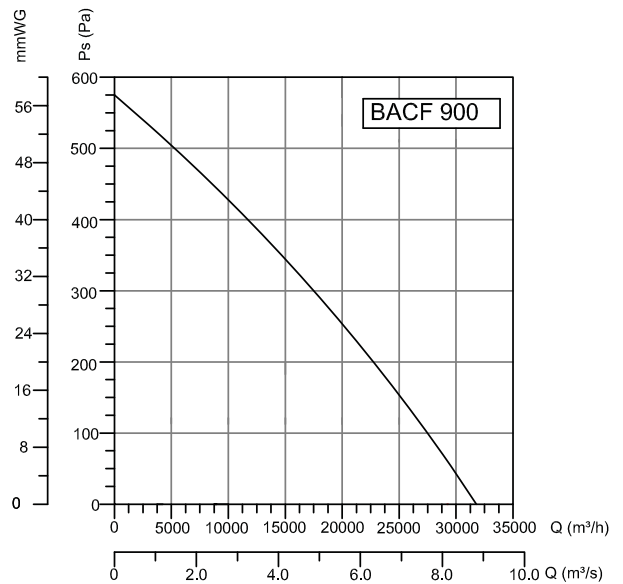
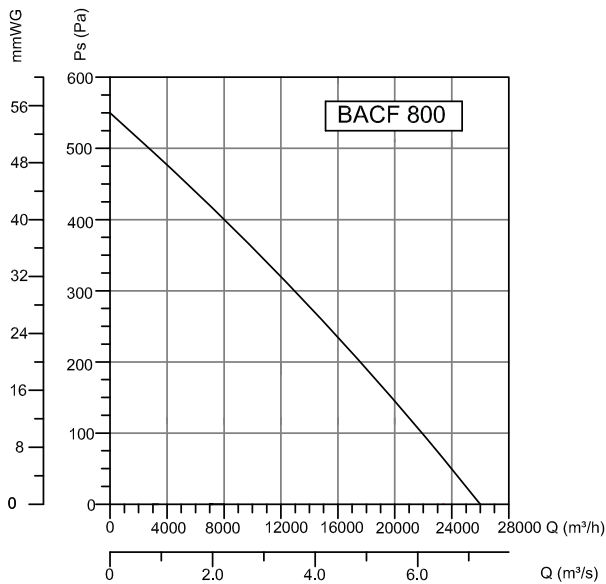
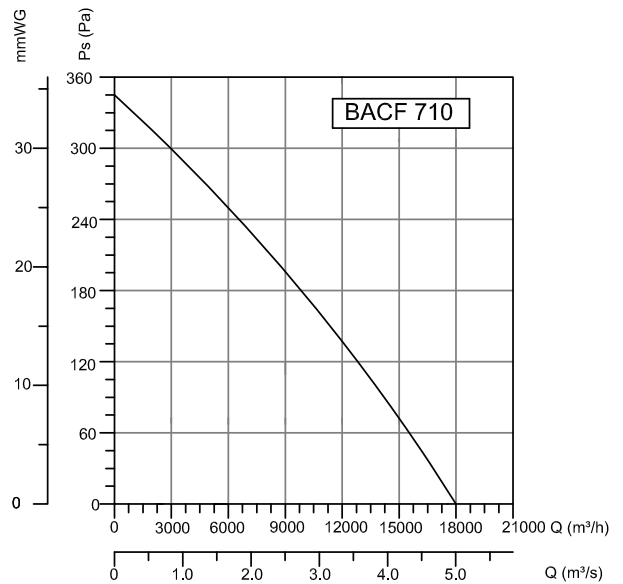
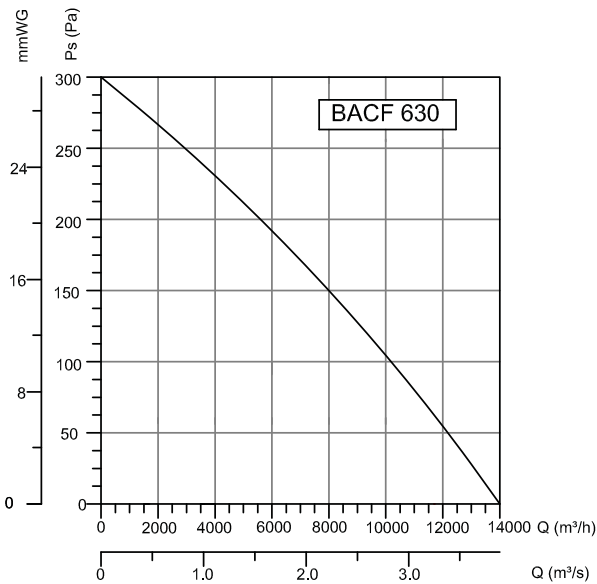
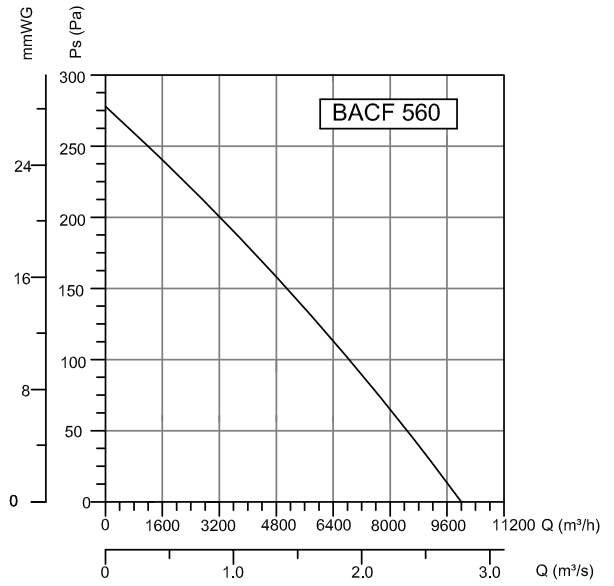
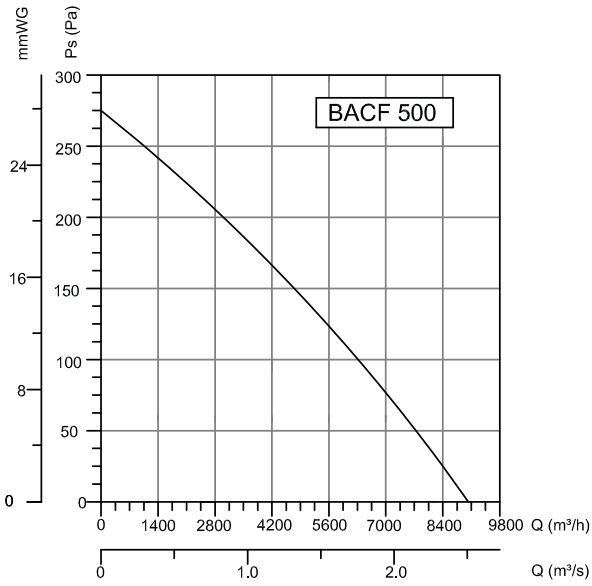

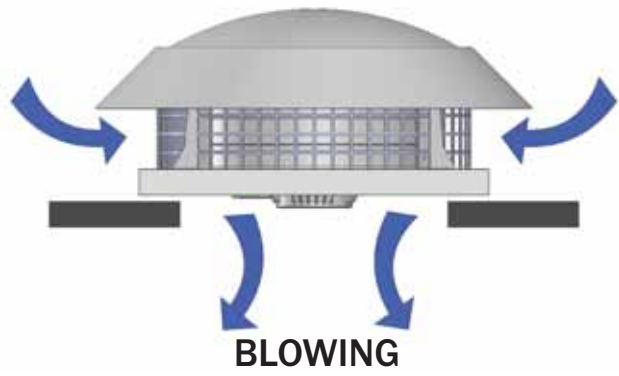
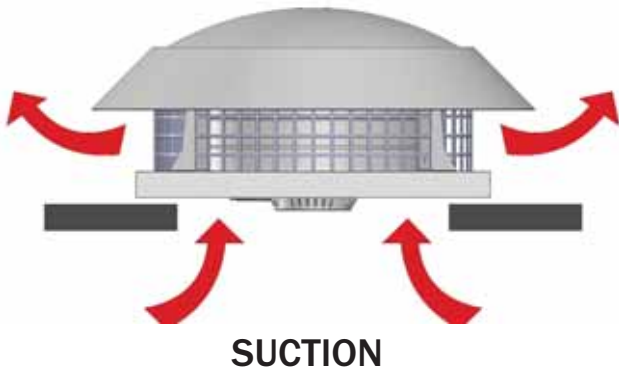
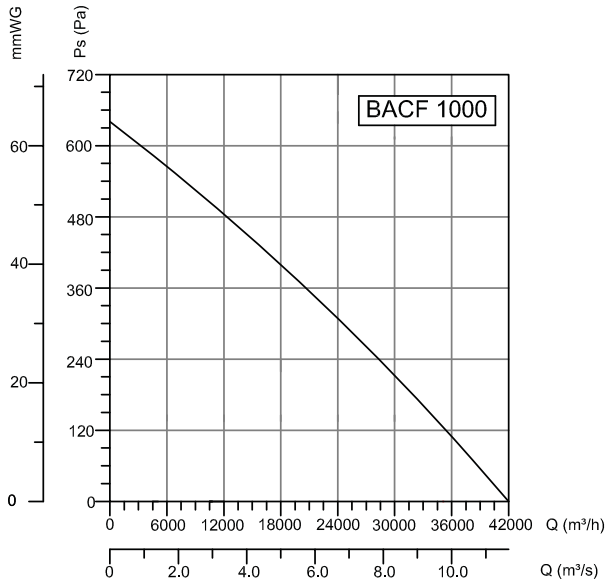

DUCT FANS

ROOF FANS

AXIAL FANS

RADIAL FANS

PLASTIC FANS

VENTILATORS

SMOKE EXHAUST SYSTEMS

ACCESSORIES